

F-PM100 Multifunctional Advanced Power Meter User Manual	Product Version	Page
	V1.0	
	Product Name: F-PM100	Total:

F-PM100

**Multifunctional Advanced Power Meter
For Power Distribution System**

User Manual

Version 1.0



1. Product Introduction

Multi-function power meter, a multi-function intelligent power meter with full power acquisition, programmable measurement, display, RS485 digital communication and switch input, relay output, it can complete three-phase electrical measurement (includes three-phase voltage, three-phase current, active power, reactive power, apparent power, power factor, frequency, harmonics, multi-rates, demand, SOE event records, etc.), four quadrant energy metering, data display, acquisition and transmission, therefore it can be widely used in substation automation, distribution automation, intelligent building, internal energy measurement, management, assessment for company. Using the special measurement chip, the power meter could achieve large-screen LCD liquid crystal display and RS-485 communication interface, communication protocol is the standard MODBUS-RTU.

2. Technical Parameters and Indicators

Working Power Supply	220VAC±10% or 85~265VAC/DC
Working Temperature	-10℃ ~ +55℃
Storage Temperature	-40℃ ~ +70℃
Operating and storage Humidity	5% ~ 95%, no condensation
Insulation Grade	Meet the requirement of standard EN61010-1
Operating Frequency	50/60Hz
Product Life	≥10 years
Size	Display Panel: 96mm×96mm×12mm(W×H×D) Main Unit: 96mm×96mm×75mm(W×H×D)
Weight	About 400G
Protection Grade	Operational Panel IP54, IP20 Side and Back Panel IP20
Input characteristics	Current Measurement: 5A/1A Voltage Measurement: 57.5/220V (AC Phase Voltage RMS)
Input Characteristics	Breaking parameters: 5A@250VAC Resistive load: 5A@30VDC
Communication	Communication Interface: RS485 Communication Protocol: MODBUS-RTU Communication Rates: 1200/2400/4800/9600/19200/38400bps Range of the Power Meter Address: 1 ~ 254
<i>Note: Indicates that the function parameter is related to the order type.</i>	

Parameter	Accuracy	Measuring range
Voltage	0.2	0 ~ 999,999V
Current	0.2	0 ~ 49,999A
Power Factor	0.5	-1.0< CosΦ <+1.0
Active Power	0.5	Single-Phase: 0 ~ 100MW Total: 0 ~ 300MW
Reactive Power	0.5	Single-Phase: 0 ~ 100Mvar Total: 0 ~ 300Mvar
Apparent power	0.5	Single-Phase: 0 ~ 100MVA Total: 0 ~ 300MVA
Electrical Degree	0.5	0 ~ 9999999.9kWh/kvarh
Frequency	0.1Hz	45 ~ 65Hz

3. Installation and Wiring

- Drill a hole of 91 * 91mm on the switch cabinet panel.
- Take out the Power Meter, release the the fixed bolts on both sides of Power Meter , remove the metal fixed bracket.
- Insert the Power Meter into the mounting hole from the front panel.
- Insert the metal fixed bracket and screw the bolts to fix the power meter.

3.2 Definition of the Terminal block on Power Meter

Number	Code	Definition
1	Ia*	A Phase current line
2	Ia	A Phase current outlet
3	Ib*	B Phase current line
4	Ib	B Phase current outlet
5	Ic*	C Phase current line
6	Ic	C Phase current outlet
7	Ua	A Phase voltage
8	Ub	B Phase voltage
9	Uc	C Phase voltage
10	Un	Neutral line
11*	A	RS485 Communication Interface Positive
12*	B	RS485 Communication Interface Negative
13*	COM	Binary Input of the Public Terminal
14*	DI1	Binary Input 1
15*	DI2	Binary Input 2

16*	DI3	Binary Input 3
17*	R11	Relay 1 Output
18*	R12	Relay 1 Output
19*	R21	Relay 2 Output
20*	R22	Relay 2 Output
21	N/-	AC power supply 220V Zero Line
22	L/+	AC power supply 220V live wire

Remark: Indicates that the terminal function is related to the order type.

3.3 Typical Wiring Diagram of the Power Meter

Wiring Diagram of Three Phrase Four Wire:

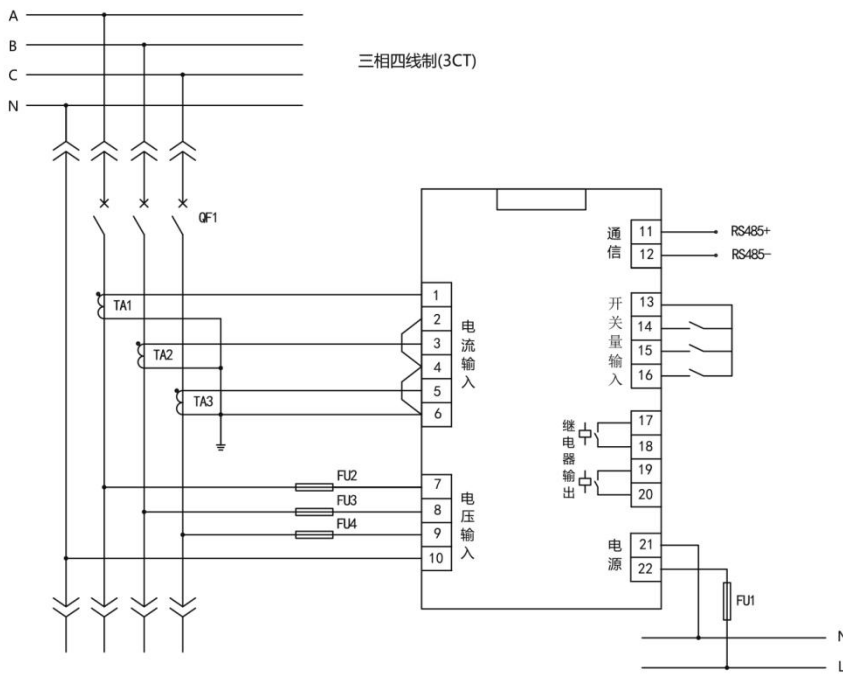

三相四线典型接线示意图

Wiring Diagram of Three Phrase Three Wire:

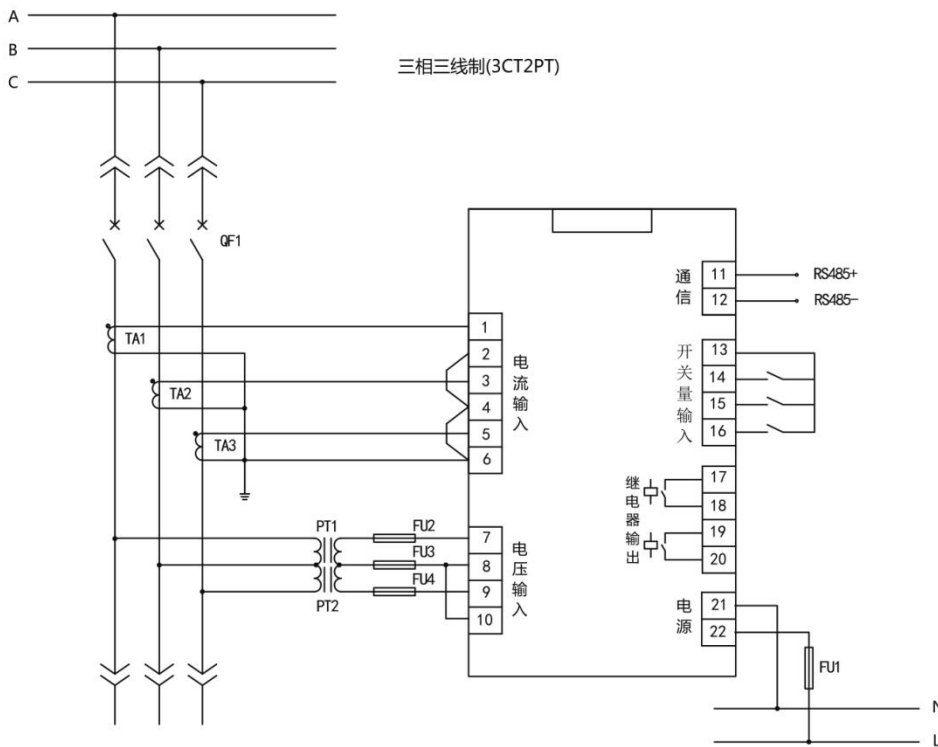

三相三线典型接线示意图

4. Power Meter Parameter Setting

4.1 Key Functions in Setup Mode:



↵ : When the cursor is flashing, select and confirm the function (Enter key);



↑ : When the cursor is flashing, modify the configuration; When the cursor is flashing, switch the parameter page (up key);

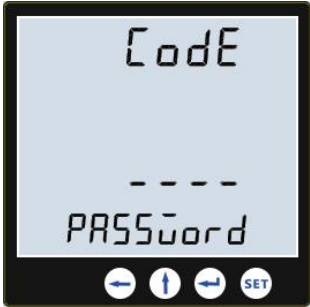

← : When the cursor is flashing, turn the cursor on the same page to the left (press the left button).



4.2 Description of the Parameter Setting



Note: Press "SET" key to enter the parameter setting interface, you can press the "↑" key to directly view the current parameters of the Power Meter. When you press the "↵" key to view the Power Meter parameters and it will pop up "need pswd" to indicate the need for a password to set up.

Page	Content	Description
1. Password Enter		<ul style="list-style-type: none"> ➤ Press "SET" key to enter into setting mode; ➤ Press " ← " key, the digital cursor will flash, prompt for the password entering , the factory default value is 0000; ➤ Press " ← " key to move the cursor position, press " ↑ " key to change the cursor value; ➤ Press the " ← " key to confirm, the LCD screen automatically jump to the next Power Meter parameter setting page indicates that the password is correct and can be operated continuously. Go to the electrical parameters display page password input error, press "SET" to re-enter the setup mode
2. Setting of the Communication Parameter		<p>Setting of Baud Rate</p> <ul style="list-style-type: none"> ➤ When the cursor is flashing, press " ↑ " key to switch to the communication parameter display interface; ➤ Press " ← " key to enter the communication parameter modification interface ➤ Press the " ← " key to move the cursor to the modification area of baud rate value. ➤ The Key recurrently display 1.2K / 2.4K / 4.8K / 9.6K / 19.2K / 38.4K, the factory default value of Power Meter is 9.6K; <p>Setting of the Check Code</p> <ul style="list-style-type: none"> ➤ Press the " ← " key to move the flashing cursor to the check code modification area ➤ Press the " ↑ " key to recurrently display the n / O / E check code range. ➤ N is a 1-bit start bit, 8-bit data bits, no parity , 1 stop bit; default is no parity; ➤ O represents 1 bit start bit, 8 bits data bit, odd parity, 1 bit stop bit. ➤ E represents 1 bit start bit, 8 bits data bit, even parity, 1 bit stop bit; <p>Setting of the Communication Setting Address</p>



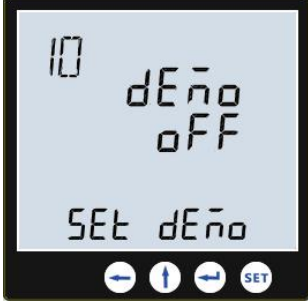

		<ul style="list-style-type: none"> ➤ The communication address range is 1 ~ 254, the factory default communication address is 1; ➤ Press the " ← " key to move the cursor to the communication address modification area; ➤ Press " ↑ " key to change the cursor value, then press " ← " key to move the cursor position; ➤ Press the " ← " key to confirm the page settings
<p>3. Setting of the System Wiring Method</p>		<p>The Power Meter supports both star and triangular measurement wiring methods.</p> <p>The default wiring method for the Power Meter is 3CT 3P4L:</p> <p>Method 1: 3CT 3P4L Method 2: 3CT 3P3L Method 3: 2CT 3P3L</p> <ul style="list-style-type: none"> ➤ When no cursor is flashing, press " ↑ " to switch to the setting page of the system wiring type ; ➤ Press " ← " to start setting; ➤ Press " ↑ " key to recurrently display 3CT 3 phase 4 wire connection page; 3CT 3 phase 3 wire connection page; 2CT 3 phase 3 wire connection page; ➤ Press the " ← " key to confirm the new wiring type.
<p>4. PT Ratio Setting</p>		<p>The Power Meter should set the correct PT ratio parameter. The setting value range is 0 ~ 350, the instrument factory default is 1.</p> <p>For example: if used in 10kV high voltage cabinet, PT value should be set to 100; If used in 380V low voltage switchgear, PT value should be set to 1.</p> <ul style="list-style-type: none"> ➤ When no cursor is flashing, press " ↑ " to switch to PT ratio setting page. ➤ Press " ← " to start the setting. ➤ Press the " ← " key to move the cursor, press " ↑ " key to change the cursor value; ➤ Press the " ← " key to confirm the PT ratio.

<p>5. Setting of CT Ratio</p>		<p>The Power Meter should set the correct CT variable ratio parameters. Value range of the setting is 0 ~ 5000, the factory default of the Power Meter is 1. For example, CT: 500/5 requires a CT value of 100.</p> <ul style="list-style-type: none"> ➤ When no cursor is flashing, press "↑" key to switch to CT variation ratio setting interface; ➤ Press "↵" to start the setting. ➤ Press the "←" key to move the cursor, press "↑" key to change the cursor value; ➤ Press the "↵" key to confirm the CT variation.
<p>6. Time Setting</p>		<p>Time Setting of the ACE series Power Meter from left to right, from top to bottom followed by years, months, days, hours, points.</p> <ul style="list-style-type: none"> ➤ When no cursor is flashing, press "↑" key to switch to time setting page; ➤ Press "↵" to start the setting; ➤ Press "←" key to move the cursor, press "↑" key to change the cursor value; ➤ Press "↵" to confirm the time.
<p>7. Backlight Setting</p>		<p>Backlight time of ACE series Power Meter counts in seconds, when the input is 060, it stands for the backlight time is 60s, the longest backlight time is 999s.</p> <ul style="list-style-type: none"> ➤ When the cursor is flashing, press "↑" to switch to the backlight time setting page; ➤ Press "↵" to start the setting ➤ Press "←" key to move the cursor, press "↑" key to change the cursor value; ➤ Press "↵" to confirm the backlight time.

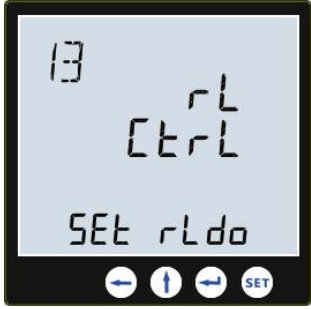
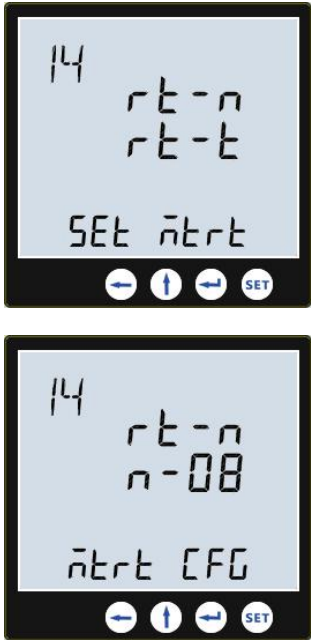
<p>8. Preset the Total Active Power</p>		<p>You can manually enter the base of active power .</p> <ul style="list-style-type: none"> ➤ When no cursor is flashing, press "↑" to switch to the setting page; ➤ Press "←" to start the setting; ➤ Press "←" key to move the cursor, press "↑" key to change the cursor value; ➤ After the active power value is set, press the "←" key to move the cursor to the S-n position, press "↑" to change n to 4, press "←" to save the active power.
<p>9. Preset the Total Reactive Power</p>		<p>You can manually enter the base of reactive power</p> <ul style="list-style-type: none"> ➤ When no cursor is flashing, press "↑" to switch to the setting page; ➤ Press "←" to start the setting; ➤ Press "←" key to move the cursor, press "↑" key to change the cursor value; ➤ After the reactive power value is set, press the "←" key to move the cursor to the S-n position, press "↑" to change n to 4, press "←" to save the reactive power.
<p>10. Clear the Power Setting</p>		<p>Operator could manually clear the electrical value</p> <ul style="list-style-type: none"> ➤ When no cursor is flashing, press "↑" to switch to the setting page; ➤ Press "←" to start the setting; ➤ Press "↑" to change on to YES, press "←" to confirm the clearance of the electrical degree.

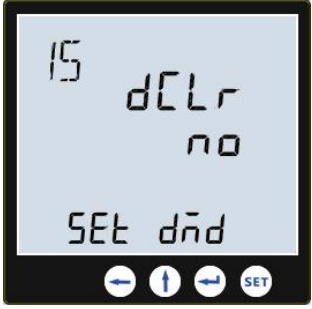
<p>11. Settings of the Presentation Mode</p>		<p>Power Meter enters into the presentation mode</p> <ul style="list-style-type: none"> ➤ When no cursor is flashing, press "↑" to switch to the setting page; ➤ Press "←" to start the setting; ➤ Press "↑" to change OFF to ON, press "←" to confirm the entrance of the presentation mode.
<p>12. Setting of the Password Change</p>		<ul style="list-style-type: none"> ➤ Power Meter enters into the interface of the password change. ➤ When no cursor is flashing, press "↑" to switch to the setting page; ➤ Press "←" to start the setting; ➤ Press "←" key to move the cursor, press "↑" key to change the cursor value; ➤ After the password is set, press "←" key to move the cursor to S-n, press "↑" to change the n to 4, then press "←" to save.
<p>13. Setting of the Relay Pulse Width</p>		<p>The relay output pulse width of the Power Meter Setting counts in milliseconds. The minimum pulse width of the relay is set to 100ms and the maximum setting is 99900ms. The factory default of the relay output pulse width is 2000ms.</p> <ul style="list-style-type: none"> ➤ When no cursor is flashing, press "↑" key to switch to register pulse width setting page; ➤ Press "←" to start the setting; ➤ Press "←" key to move the cursor, press "↑" key to change the cursor value; ➤ Press "←" to confirm the pulse width setting.

<p>14. Manual controlling of Relay Output</p>		<p>The password of the manual controlling relay output is 4131.</p> <ul style="list-style-type: none"> ➤ When no cursor is flashing, press "↑" to switch to the page; ➤ Press "←" to start the setting; ➤ Press the "←" key to select the relay that needs to be operated, rL-1 means "relay 1", rL-2 means "relay 2" ➤ Select the relay that needs to be operated and press "←" to start; ➤ Press "↑" key to switch to 00, press "←" key to move the cursor, press "↑" key to change the cursor value to set the password; ➤ Press "←" to confirm the controlling of relay output; ➤ Press the "SET" key to exit the manual controlling of relay output.
<p>14. Multi-Rate Setting</p>		<p>Multi-rate setting of the Power Meter: rt-n stands for rate section, rt-t stands for rate time.</p> <ul style="list-style-type: none"> ➤ When no cursor is flashing, press "↑" key to switch to the Multi-rate setting page; ➤ Press "←" to start the setting; ➤ Then press "←" key to set the rate section, press "↑" key to change the cursor value to set the rate section; ➤ Press "←" key to save the setting of rate period; ➤ Press "←" key to enter the rate time setting (press "←" key to switch the rate period) ➤ press "←" key to confirm the entry of rate time

		<p>setting, rn-0, rn-1, rn-2, rn-3, respectively stands for the tip, peak, flat, valley rates.</p> <ul style="list-style-type: none"> ➤ Press "←" key to move the cursor, press "↑" key to change the cursor value to set the rate period and rate time; ➤ Press "↵" key to save the setting; ➤ Press the "SET" key to exit the setting of the multiple rate.
<p>15. Demand Value Clearance</p>		<p>The Power Meter clears the maximum demand value</p> <ul style="list-style-type: none"> ➤ When no cursor is flashing, press "↑" to switch to the setting page; ➤ Press "↵" to start the setting; ➤ Press "↑" key to switch no to YES, press "↵" key to clear the maximum demand value.
<p>16. Event Sequence Record Clearance</p>		<p>Sequence of events record clearance for Power Meter (SOE)</p> <ul style="list-style-type: none"> ➤ When no cursor is flashing, press "↑" to switch to the page; ➤ Press "↵" to start the setting; ➤ Press "↑" key to switch no to YES, press "↵" key to clear all event sequence records .
<p>17. Multi-Rate Clearance</p>		<p>Multi-rate clearance setting for Power Meter.</p> <ul style="list-style-type: none"> ➤ When no cursor is flashing, press "↑" key to switch to the multi-rate setting page; ➤ Press "↵" to start the setting; ➤ Press "↑" key to switch no to YES, press "↵" key to clear all original multi-rate parameters .
<p>18. Alarm Value Setting</p>		<p>Alarm Value Setting for the Power Meter</p> <ul style="list-style-type: none"> ➤ When no cursor is flashing, press "↑" to switch to the page; ➤ Press "↵" to start the setting; <p>The alarm value setting page has 10 screens in total. (1) Phase voltage overvoltage value and phase voltage</p>

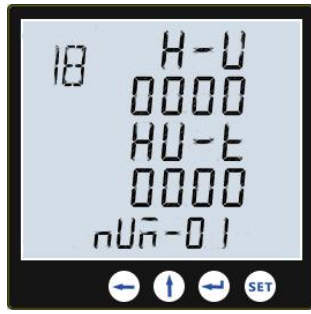

overvoltage time;
 (2) Phase voltage undervoltage value and phase voltage ;
 undervoltage time;
 (3) Overcurrent value and overcurrent time ;
 (4) Zero sequence overcurrent value and zero sequence
 overcurrent time;
 (5) 5 Phase loss threshold and phase delay time;
 (6) Low PF value and low PF setting time;
 (7) Over frequency value and time of over Frequency
 value ;
 (8) Low-frequency value and time of low-frequency value;
 (9) Voltage unbalance rating and time of voltage unbalance
 value;
 (10) Current unbalance value and time of current unbalance
 value。

- Press " ← " to switch;
- Press " ← " key to start each phase setting;
- Press " ← " key to move the cursor , press " ↑ " key to
change the value of the cursor and to set the value and
time;
- Press " ← " key to save the setting.
- Press "SET" key to exit the setting of alarm value.

19. Alarm
Output
Setting



Alarm Output Setting for the Power Meter

- When no cursor is flashing, press " ↑ " to switch to the
setting page;
- Press " ← " to start the setting;

The alarm output setting page has 12 screens in total :

1. Relay 1 control item;
2. Relay 1 upper limit alarm value and relay 1 lower limit
alarm value;
3. Relay 1 alarm hysteresis and relay 1 alarm delay value;
4. Relay 2 control Item;
5. Relay 2 upper limit alarm value and relay 2 lower limit
alarm value;
6. Relay 2 alarm hysteresis and relay 2 alarm delay value ;
7. Relay 3 control item;
8. Relay 3 upper limit alarm value and relay 3 lower limit
alarm value;
9. Relay 3 alarm hysteresis and relay 3 alarm delay value;
10. Relay 4 control item;
11. Relay 4 upper limit alarm value and relay 4 lower limit

		<p>alarm value;</p> <p>12. Relay 4 alarm hysteresis and relay 4 alarm Delay value;</p> <ul style="list-style-type: none"> ➤ Press " ← " to switch; ➤ Press " ← " key to start each phase setting; ➤ Press " ← " key to move the cursor, press " ↑ " key to change the cursor value to set the alarm value; ➤ Press " ← " key to save the setting; ➤ Press "SET" key to exit the alarm output setting.
20	The device name and version number	Meter device name and version number.